

TESTDAVIT

› Assembly & Operation Guide

Contents

Inspection 4

Introduction 6

Product Information and dimensions

Example of Test Davit Proof Load

Loading Required for Testing

Assembly Instructions 8

Assembling the Davit

Stahl Device

PORTAGANTRY RAPIDE

Notes 14

Lightweight. Portable. **Safe.**

Please read the following instructions and guidance notes carefully, before using or operating the system.

They contain important information about how to handle and use the system in a safe and efficient way, avoiding danger, reducing repair costs and downtime, and increasing the reliability and lifespan of the system.

They apply for:

- Operation, including preparation, troubleshooting during operation and cleaning
- Maintenance, inspection, repair

It is the responsibility of the end user to adhere to the Health & Safety and accident prevention standards and legislation valid in their respective countries and any regions in which the system is being used. It is also incumbent on the user or competent person to ensure that anyone working with the equipment has the necessary medical and physical capabilities. A rescue plan also needs to be in place in the event of an emergency that could occur during the work. This document should form part of the overriding Risk Assessment and Method Statement required for each lift.

› Inspection

Inspection

- › As part of a scheduled inspection the test davit should be examined to ensure all components are in good condition and function as intended. Particular attention should be given to all hardware and fixing points as well as wear or deformation to the king pin.
- › It should be noted that the king pin has an interface which ensures the unit is unable to lift out the socket as high loads are applied, this interface can overtime show signs of wear, it is intended that the king pin element of the test davit will wear first to protect the socket, the life of the king pin will vary depending on the application and test loads applied as such the king pin should be inspected before each use to ensure that no excessive wear has occurred. Regular rotation of the king pin is prudent to stop repeated wear in the same area.
- › If the king pin has become worn so that the interface surface no longer offers a lip for the pin to engage with the socket the king pin assembly should be replaced.

➤ Portable Socket Test Davit from REID

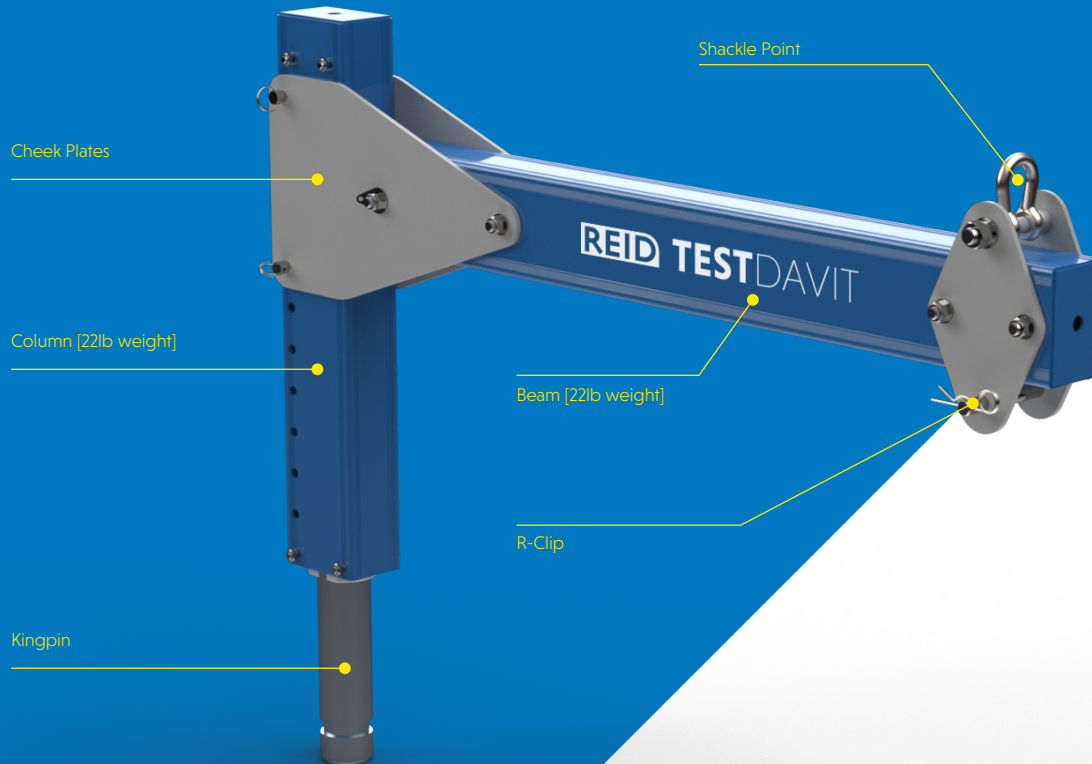

The **REID Test Davit** has been engineered to ensure maximum safety standards can be met where **fixed sockets** are concerned. The Test Davit allows the user to test the strength and stability of fixed sockets up to 2160lbf.m.

Product Information and Dimensions

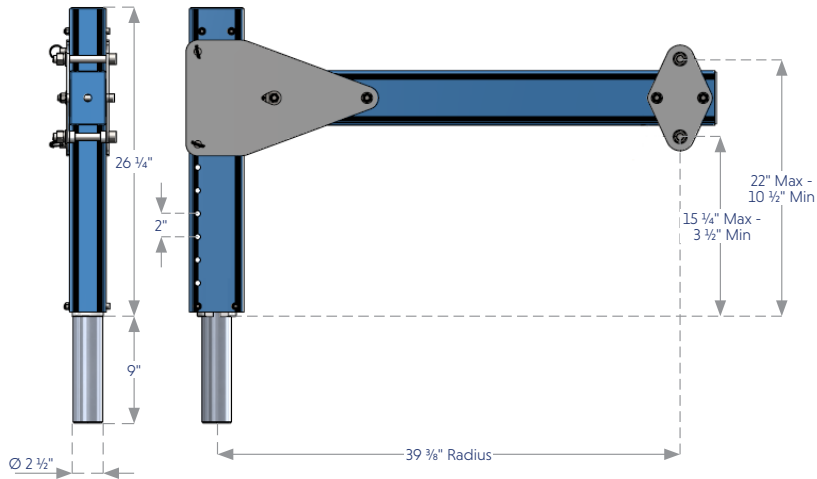

Example of a custom goods only TDAVIT:

WLL = 300kg (660lb) or 2.94kN (661lbf) $\left(\frac{300 \times 9.81}{1000}\right)$

Radius = 1600mm or 1.6m (63")

Test Davit Proof Load

$(2.94 \times 1600 \times 125\%) = 5.88\text{kN (1322lbf)}$

Loading Required for Testing		
PPE		
Radius* [in]	Service Load [lbf]	Load to apply to Test Davit [lbf]
31 1/2"	1350	1080
39 3/4"	1350	1350
47 3/4"	1350	1620
63"	1350	2160
Goods Only		
Radius [in]	Capacity [lb]	Load to apply to Test Davit [lbf]
31 1/2"	1320	1330
39 3/4"	1100	1395
47 3/4"	1100	1665
63"	825	1665
78 3/4"	660	1665

For goods only the proof load is equal to the WLL x 125%.
Test Davit loading = radius x service load

*Radius relates to the length of the beam of the davit that is used in the lifting operation and **not** the length of the test davit beam.

➤ Assembly Instructions

The following instructions document how to correctly assemble the Test Davit using a top mount socket.

Appropriate PPE should be worn: ➤ **Gloves** ➤ **Protective Footwear** ➤ **Hard Hat**

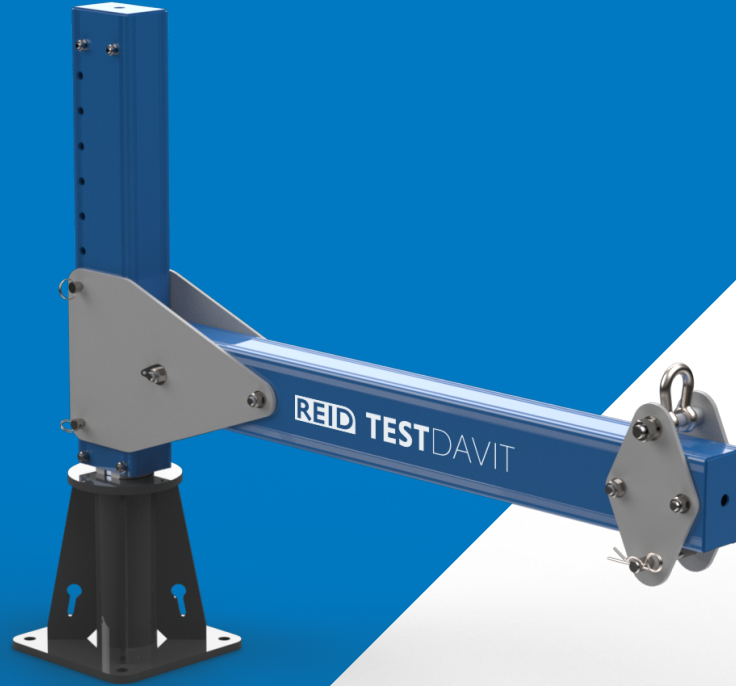



1 > Insert the column into the socket.

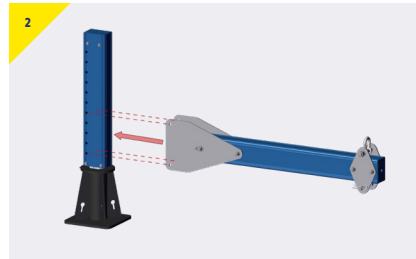

2 > Present the Davit beam to the column at the required height.

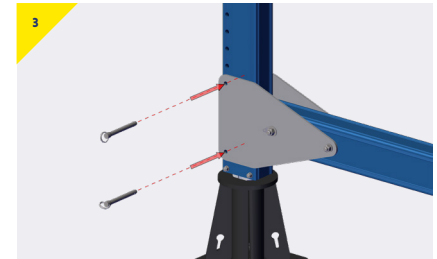

3 > Secure the Davit using the detent pins provided.

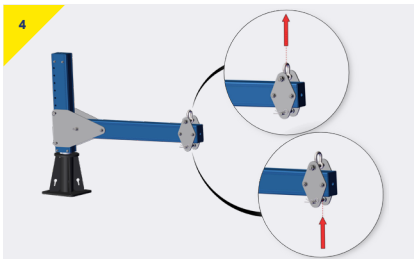

4 > Depending on the device used for testing the socket, pull or push up the Test Davit using the necessary equipment to the required load.

5

Once the Davit has been assembled in place it is ready for a device to be attached to the shackle point or clevis pin to begin the test.

➤ Assembly Instructions - Staht Device

The following instructions document how to correctly assemble a Staht anchor test device with the **REID TESTDAVIT** to correctly test the force of the socket.

Appropriate PPE should be worn: ➤ **Gloves** ➤ **Protective Footwear** ➤ **Hard Hat**

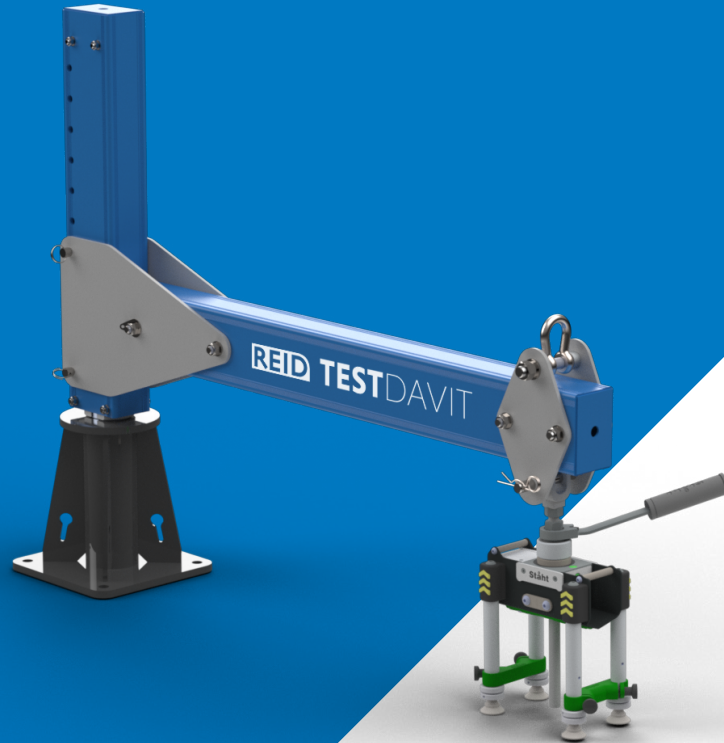

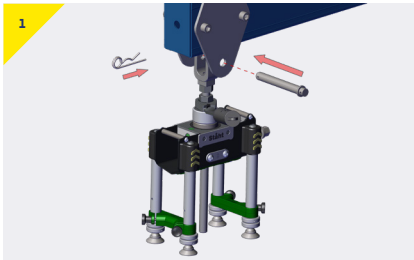

- With the drop rod in its lowest position, place the device underneath the beam and secure using the supplied clevis pin and r-clip.

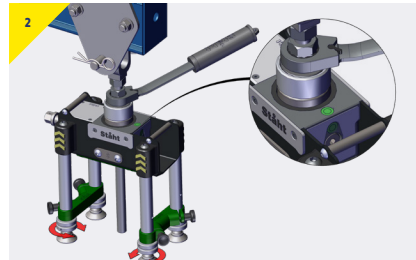

- Ensure device is level by adjusting the feet and checking the bullseye level.

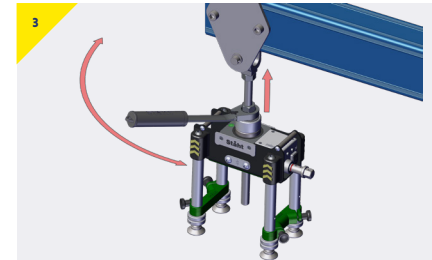

- Engage the ratchet and apply the load. Once the required loading has been achieved, hold the load for the amount of time determined by the local authority regulations. De-load by rotating the ratchet in the opposite direction.

▶ Assembly Instructions - PORTAGANTRY RAPIDE®

The following instructions document how to correctly assemble a **PORTAGANTRY RAPIDE®** and a chain block* with the **REID TEST DAVIT** to correctly test the force of the socket.

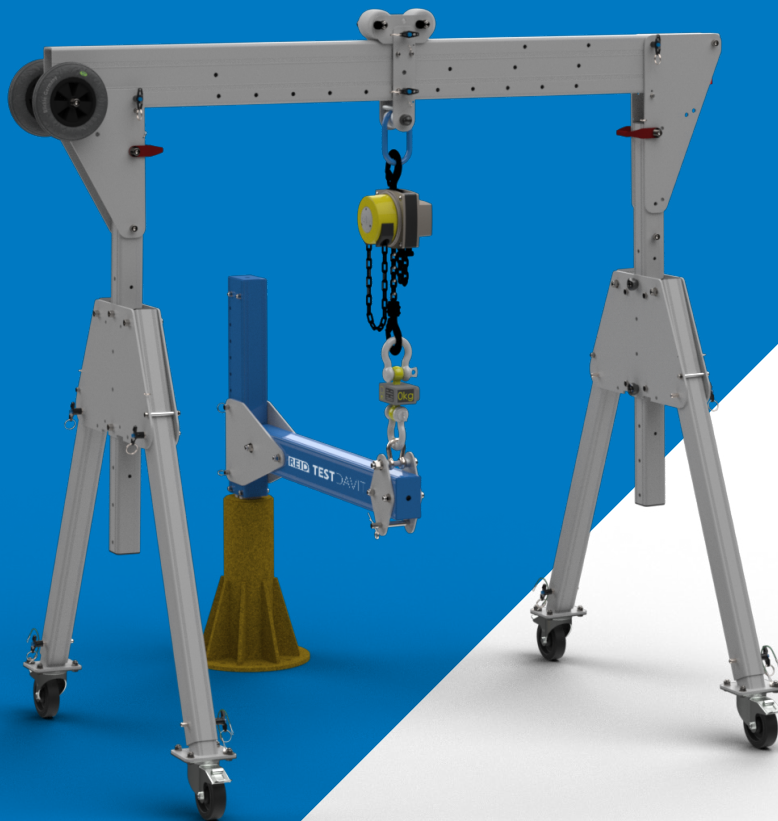

Appropriate PPE should be worn: ▶ Gloves ▶ Protective Footwear ▶ Hard Hat



- Position the **PORTA GANTRY RAPIDE** over the test davit ensuring the trolley sits directly above the shackle on the beam.



- Fit the chain block and the loadcell in between the trolley on the gantry and the shackle on the test davit.



- Ensuring the loadcell reads 0 before starting. Apply load to the test davit using the chain block. Once the required loading has been achieved hold the load for the amount of time determined by the local authority regulations. De-load the test davit by reversing the chain block.

*Please refer to the correct operations and assembly guide for the relevant **PORTA GANTRY RAPIDE** before use. These can be found online at [US.REIDLIFTING.COM](https://www.us.reidlifting.com).

Contact Us

REID Lifting Inc, USA

7900 International Drive,
Suite 300,
Bloomington,
MN 55425
USA

- > +1-(888)-721-6411
- > info@reidlifting.com
- > us.reidlifting.com

All information herein is copyright protected by REID Lifting Ltd. All company and product names are Trade Mark and Trade Name protected and all REID Lifting Ltd. Product IPR is protected under Patents, Patents Pending and/or Design Rights.



Printed using environment friendly processes and materials.